



Logan Bearing Data Sheets



2822 Sable Mill Rd., Jeffersonville, IN 47130
sales@1stsourceproducts.com
www.1stsourceproducts.com



2822 Sable Mill Rd., Jeffersonville, IN 47130

PH: 812-288-7466 FAX: 812-252-4728

<https://www.1stsourceproducts.com>

Email: sales@1stsourceproducts.com

#11 SERIES LOGAN BEARING DATA SHEET

Model #11-LL Part Number 2-0054-001

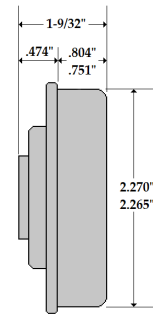

O.D. 2.270" - 2.265", HEX Bore 11/16" 300 lb. Weight Capacity,
11 each 3/8" diameter carbon steel ball bearings, Shipping Weight: 4 OZ.

*NOTE: These drawings indicate Basic Bearing Configurations. Contact 1st Source Products, Inc. for certified dimensions. Alternate Bearing Construction, such as: Lubrication, Grease Packed, Zinc Plated, Foundry, Heat Treated, Shot Shield Construction & Round Bore are available for Most bearings shown.



2822 Sable Mill Rd., Jeffersonville, IN 47130

PH: 812-288-7466 FAX: 812-252-4728

<https://www.1stsourceproducts.com>

Email: sales@1stsourceproducts.com

#11 SERIES LOGAN BEARING DATA SHEET

The Dust-Protected Bearing (Style D) is provided with an outer shield which is fixed to the stationary inner race of the bearing, and does not touch any rotating part. In a reasonably dry-atmosphere, excellent results are obtained with no lubrication.

The Grease-Packed Bearing (Style GP) features the same construction as the Dust-Protected Bearing, but is pre-lubricated during assembly with a special long-life grease.

Lubricated-for-Life Bearings are constructed similar to the Dust-Protected type including the same labyrinth outer seal, but with an added built-in inner seal. Bearing is pre-lubricated during assembly with a special long-life grease.

The Lubricated-for-Life Bearing is recommended for Power Driven Rollers as used in Live Roller or Belt Conveyors. Also, suitable for Push Line Roller Conveyor, but NOT for Gravity Lines. DO NOT use this type in areas where there is dirt or grime, as this type has no provision for cleaning or re-greasing as with the Pressure-Lubricated Bearing.

Pressure-Lubricated Bearing construction is similar to the Dust-Protected, with the addition of a grease chamber behind the bearing plus a grease duct and pressure fitting in the shaft. The floating cup in the rear of chamber prevents entry of grease into interior of roll.

Alternate Bearing construction such as Lubricated-for-Life (Style LL), Pressure-Lubricated (Style L), Grease Packed (Style GP), Zinc Plated (Style ZP), and Round Bore (Style R) are available on most Bearings shown.

Note: These drawings indicate basic configurations. Do not use for design or construction. Contact 1st Source Products Inc. for certified dimensions.

Also, available in Stainless Steel – contact 1st Source Products Inc. for specifications and availability.

Also, available in Heat-Resistant version – contact 1st Source Products Inc. for specifications and availability.

PURCHASING DESCRIPTION:

General form: Bearing No./Style

Example: 11-LL Part No. 2-0054-001



2822 Sable Mill Rd., Jeffersonville, IN 47130
PH: 812-288-7466 FAX: 812-252-4728
<https://www.1stsourceproducts.com>
Email: sales@1stsourceproducts.com

#13 SERIES LOGAN BEARING DATA SHEET

Model #13-D Part Number 2-0068-001



O.D. 2.321"/2.313", HEX Bore 11/16" 300 lb. Weight Capacity,
13 each 3/8" diameter carbon steel ball bearings, Shipping Weight: 4 OZ.

Model #13 Part Number 2-0066-001



O.D. 2.321"/2.313", HEX Bore 11/16" 300 lb. Weight Capacity,
13 each 3/8" diameter carbon steel ball bearings, Shipping Weight: 4 OZ.

*NOTE: These drawings indicate Basic Bearing Configurations. Contact 1st Source Products, Inc. for certified dimensions. Alternate Bearing Construction, such as: Lubrication, Grease Packed, Zinc Plated, Foundry, Heat Treated, Shot Shield Construction & Round Bore are available for Most bearing shown.



2822 Sable Mill Rd., Jeffersonville, IN 47130

PH: 812-288-7466 FAX: 812-252-4728

<https://www.1stsourceproducts.com>

Email: sales@1stsourceproducts.com

#13 SERIES LOGAN BEARING DATA SHEET

The Dust-Protected Bearing (Style D) is provided with an outer shield which is fixed to the stationary inner race of the bearing, and does not touch any rotating part. In a reasonably dry-atmosphere, excellent results are obtained with no lubrication.

The Grease-Packed Bearing (Style GP) features the same construction as the Dust-Protected Bearing, but is pre-lubricated during assembly with a special long-life grease.

Lubricated-for-Life Bearings are constructed similar to the Dust-Protected type including the same labyrinth outer seal, but with an added built-in inner seal. Bearing is pre-lubricated during assembly with a special long-life grease.

The Lubricated-for-Life Bearing is recommended for Power Driven Rollers as used in Live Roller or Belt Conveyors. Also, suitable for Push Line Roller Conveyor, but NOT for Gravity Lines. DO NOT use this type in areas where there is dirt or grime, as this type has no provision for cleaning or re-greasing as with the Pressure-Lubricated Bearing.

Pressure-Lubricated Bearing construction is similar to the Dust-Protected, with the addition of a grease chamber behind the bearing plus a grease duct and pressure fitting in the shaft. The floating cup in the rear of chamber prevents entry of grease into interior of roll.

Alternate Bearing construction such as Lubricated-for-Life (Style LL), Pressure-Lubricated (Style L), Grease Packed (Style GP), Zinc Plated (Style ZP), and Round Bore (Style R) are available on most Bearings shown.

Note: These drawings indicate basic configurations. Do not use for design or construction. Contact 1st Source Products Inc. for certified dimensions.

Also, available in Stainless Steel – contact 1st Source Products Inc. for specifications and availability.

Also, available in Heat-Resistant version – contact 1st Source Products Inc. for specifications and availability.

PURCHASING DESCRIPTION:

General form: Bearing No./Style

Example: 13-D Part No. 2-0068-001



2822 Sable Mill Rd., Jeffersonville, IN 47130
PH: 812-288-7466 FAX: 812-252-4728
<https://www.1stsourceproducts.com>
Email: sales@1stsourceproducts.com

#20 SERIES LOGAN BEARING DATA SHEET

Model #20-D Part Number 2-0041-001

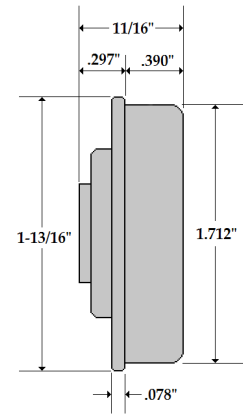

O.D. 1.712", HEX 7/16" 135 lb. Weight Capacity,
12 each 9/32" diameter ball bearings, Shipping Weight: 4 OZ.

Model #20-LL Part Number 2-0042-001

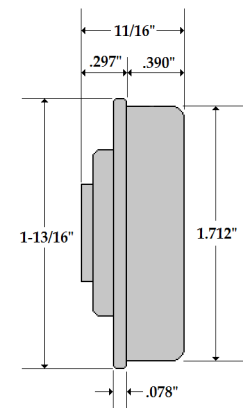

O.D. 1.712", HEX 7/16" 135 lb. Weight Capacity,
12 each 9/32" diameter ball bearings, Shipping Weight: 4 OZ.

*NOTE: These drawings indicate Basic Bearing Configurations. Contact 1st Source Products, Inc. for certified dimensions. Alternate Bearing Construction, such as: Lubrication, Grease Packed, Zinc Plated, Foundry, Heat Treated, Shot Shield Construction & Round Bore are available for Most bearing shown.



2822 Sable Mill Rd., Jeffersonville, IN 47130

PH: 812-288-7466 FAX: 812-252-4728

<https://www.1stsourceproducts.com>

Email: sales@1stsourceproducts.com

#20 SERIES LOGAN BEARING DATA SHEET

The Dust-Protected Bearing (Style D) is provided with an outer shield which is fixed to the stationary inner race of the bearing, and does not touch any rotating part. In a reasonably dry-atmosphere, excellent results are obtained with no lubrication.

The Grease-Packed Bearing (Style GP) features the same construction as the Dust-Protected Bearing, but is pre-lubricated during assembly with a special long-life grease.

Lubricated-for-Life Bearings are constructed similar to the Dust-Protected type including the same labyrinth outer seal, but with an added built-in inner seal. Bearing is pre-lubricated during assembly with a special long-life grease.

The Lubricated-for-Life Bearing is recommended for Power Driven Rollers as used in Live Roller or Belt Conveyors. Also, suitable for Push Line Roller Conveyor, but NOT for Gravity Lines. DO NOT use this type in areas where there is dirt or grime, as this type has no provision for cleaning or re-greasing as with the Pressure-Lubricated Bearing.

Pressure-Lubricated Bearing construction is similar to the Dust-Protected, with the addition of a grease chamber behind the bearing plus a grease duct and pressure fitting in the shaft. The floating cup in the rear of chamber prevents entry of grease into interior of roll.

Alternate Bearing construction such as Lubricated-for-Life (Style LL), Pressure-Lubricated (Style L), Grease Packed (Style GP), Zinc Plated (Style ZP), and Round Bore (Style R) are available on most Bearings shown.

Note: These drawings indicate basic configurations. Do not use for design or construction. Contact 1st Source Products Inc. for certified dimensions.

Also, available in Stainless Steel – contact 1st Source Products Inc. for specifications and availability.

Also, available in Heat-Resistant version – contact 1st Source Products Inc. for specifications and availability.

PURCHASING DESCRIPTION:

General form: Bearing No./Style

Example: 20-LL Part No. 2-0042-001



2822 Sable Mill Rd., Jeffersonville, IN 47130

PH: 812-288-7466 FAX: 812-252-4728

<https://www.1stsourceproducts.com>

Email: sales@1stsourceproducts.com

#50 SERIES LOGAN BEARING DATA SHEET

Model #50-D Part Number 4-0191-002

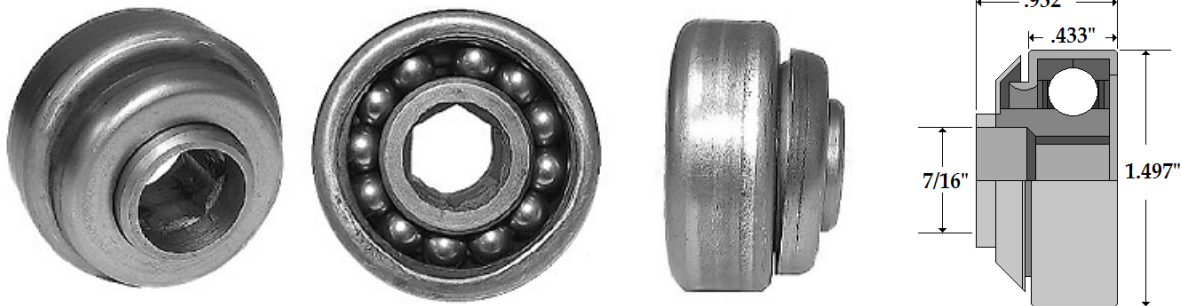

O.D. 1.497", HEX 7/16" 135 lb. Weight Capacity,
12 each 1/4" diameter carbon steel ball bearings, Shipping Weight: 4 OZ.

Model #50-LL Part Number 4-0191-003



O.D. 1.497", HEX 7/16" 135 lb. Weight Capacity,
12 each 1/4" diameter carbon steel ball bearings, Shipping Weight: 4 OZ.

*NOTE: These drawings indicate Basic Bearing Configurations. Contact 1st Source Products, Inc. for certified dimensions. Alternate Bearing Construction, such as: Lubrication, Grease Packed, Zinc Plated, Foundry, Heat Treated, Shot Shield Construction & Round Bore are available for Most bearing shown.



2822 Sable Mill Rd., Jeffersonville, IN 47130
PH: 812-288-7466 FAX: 812-252-4728
<https://www.1stsourceproducts.com>
Email: sales@1stsourceproducts.com

#50 SERIES LOGAN BEARING DATA SHEET

Model #50 Part Number 4-0191-001

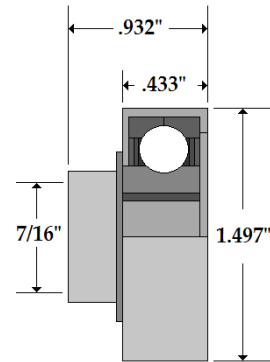

O.D. 1.497", HEX 7/16" 135 lb. Weight Capacity,
12 each 1/4" diameter carbon steel ball bearings, Shipping Weight: 4 OZ.

Model #50-RD Part Number 4-0191-004

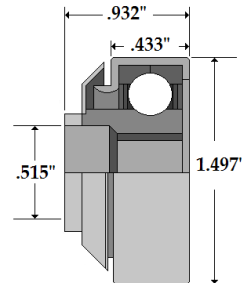

O.D. 1.497", Round Bore .515" I.D. 135 lb. Weight Capacity,
12 each 1/4" diameter carbon steel ball bearings, Shipping Weight: 4 OZ.

*NOTE: These drawings indicate Basic Bearing Configurations. Contact 1st Source Products, Inc. for certified dimensions. Alternate Bearing Construction, such as: Lubrication, Grease Packed, Zinc Plated, Foundry, Heat Treated, Shot Shield Construction & Round Bore are available for Most bearing shown.



2822 Sable Mill Rd., Jeffersonville, IN 47130

PH: 812-288-7466 FAX: 812-252-4728

<https://www.1stsourceproducts.com>

Email: sales@1stsourceproducts.com

#50 SERIES LOGAN BEARING DATA SHEET

The Dust-Protected Bearing (Style D) is provided with an outer shield which is fixed to the stationary inner race of the bearing, and does not touch any rotating part. In a reasonably dry-atmosphere, excellent results are obtained with no lubrication.

The Grease-Packed Bearing (Style GP) features the same construction as the Dust-Protected Bearing, but is pre-lubricated during assembly with a special long-life grease.

Lubricated-for-Life Bearings are constructed similar to the Dust-Protected type including the same labyrinth outer seal, but with an added built-in inner seal. Bearing is pre-lubricated during assembly with a special long-life grease.

The Lubricated-for-Life Bearing is recommended for Power Driven Rollers as used in Live Roller or Belt Conveyors. Also, suitable for Push Line Roller Conveyor, but NOT for Gravity Lines. DO NOT use this type in areas where there is dirt or grime, as this type has no provision for cleaning or re-greasing as with the Pressure-Lubricated Bearing.

Pressure-Lubricated Bearing construction is similar to the Dust-Protected, with the addition of a grease chamber behind the bearing plus a grease duct and pressure fitting in the shaft. The floating cup in the rear of chamber prevents entry of grease into interior of roll.

Alternate Bearing construction such as Lubricated-for-Life (Style LL), Pressure-Lubricated (Style L), Grease Packed (Style GP), Zinc Plated (Style ZP), and Round Bore (Style R) are available on most Bearings shown.

Note: These drawings indicate basic configurations. Do not use for design or construction. Contact 1st Source Products Inc. for certified dimensions.

Also, available in Stainless Steel – contact 1st Source Products Inc. for specifications and availability.

Also, available in Heat-Resistant version – contact 1st Source Products Inc. for specifications and availability.

PURCHASING DESCRIPTION:

General form: Bearing No./Style

Example: 50-LL Part No. 4-0191-003



2822 Sable Mill Rd., Jeffersonville, IN 47130

PH: 812-288-7466 FAX: 812-252-4728

<https://www.1stsourceproducts.com>

Email: sales@1stsourceproducts.com

#55 SERIES LOGAN BEARING DATA SHEET

Model #55-D Part Number 4-0192-002

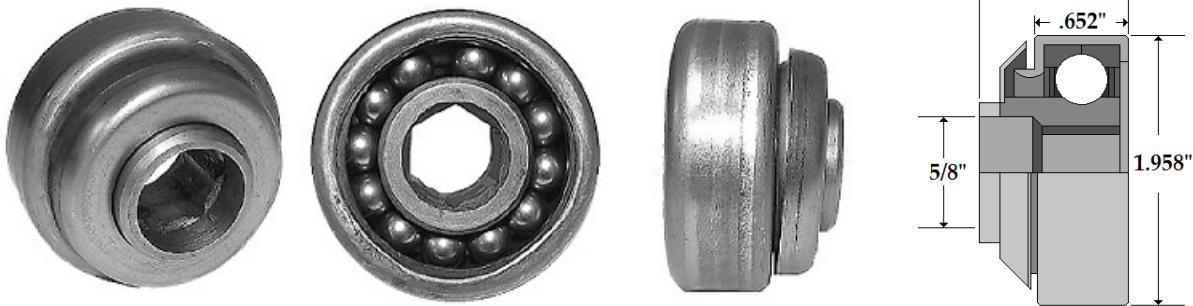

O.D. 1.958", HEX 5/8" 200 lb. Weight Capacity,
12 each 5/16" diameter carbon steel ball bearings, Shipping Weight: 4 OZ.

Model #55-LL Part Number 4-0192-003



O.D. 1.958", HEX 5/8" 200 lb. Weight Capacity,
12 each 5/16" diameter carbon steel ball bearings, Shipping Weight: 4 OZ.

*NOTE: These drawings indicate Basic Bearing Configurations. Contact 1st Source Products, Inc. for certified dimensions. Alternate Bearing Construction, such as: Lubrication, Grease Packed, Zinc Plated, Foundry, Heat Treated, Shot Shield Construction & Round Bore are available for Most bearing shown.



2822 Sable Mill Rd., Jeffersonville, IN 47130
PH: 812-288-7466 FAX: 812-252-4728
<https://www.1stsourceproducts.com>
Email: sales@1stsourceproducts.com

#55 SERIES LOGAN BEARING DATA SHEET

Model #55 Part Number 4-0192-001

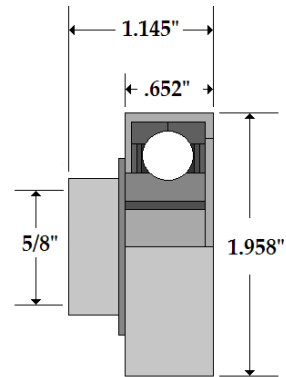

O.D. 1.958", HEX 5/8" 200 lb. Weight Capacity,
12 each 5/16" diameter carbon steel ball bearings, Shipping Weight: 4 OZ.

Model #55-RD Part Number 4-0192-004

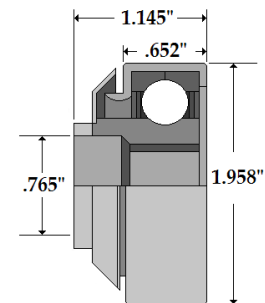

O.D. 1.958", Round Bore .765" I.D. 200 lb. Weight Capacity,
12 each 5/16" diameter carbon steel ball bearings, Shipping Weight: 4 OZ.

*NOTE: These drawings indicate Basic Bearing Configurations. Contact 1st Source Products, Inc. for certified dimensions. Alternate Bearing Construction, such as: Lubrication, Grease Packed, Zinc Plated, Foundry, Heat Treated, Shot Shield Construction & Round Bore are available for Most bearing shown.



2822 Sable Mill Rd., Jeffersonville, IN 47130

PH: 812-288-7466 FAX: 812-252-4728

<https://www.1stsourceproducts.com>

Email: sales@1stsourceproducts.com

#55 SERIES LOGAN BEARING DATA SHEET

The Dust-Protected Bearing (Style D) is provided with an outer shield which is fixed to the stationary inner race of the bearing, and does not touch any rotating part. In a reasonably dry-atmosphere, excellent results are obtained with no lubrication.

The Grease-Packed Bearing (Style GP) features the same construction as the Dust-Protected Bearing, but is pre-lubricated during assembly with a special long-life grease.

Lubricated-for-Life Bearings are constructed similar to the Dust-Protected type including the same labyrinth outer seal, but with an added built-in inner seal. Bearing is pre-lubricated during assembly with a special long-life grease.

The Lubricated-for-Life Bearing is recommended for Power Driven Rollers as used in Live Roller or Belt Conveyors. Also, suitable for Push Line Roller Conveyor, but NOT for Gravity Lines. DO NOT use this type in areas where there is dirt or grime, as this type has no provision for cleaning or re-greasing as with the Pressure-Lubricated Bearing.

Pressure-Lubricated Bearing construction is similar to the Dust-Protected, with the addition of a grease chamber behind the bearing plus a grease duct and pressure fitting in the shaft. The floating cup in the rear of chamber prevents entry of grease into interior of roll.

Alternate Bearing construction such as Lubricated-for-Life (Style LL), Pressure-Lubricated (Style L), Grease Packed (Style GP), Zinc Plated (Style ZP), and Round Bore (Style R) are available on most Bearings shown.

Note: These drawings indicate basic configurations. Do not use for design or construction. Contact 1st Source Products Inc. for certified dimensions.

Also, available in Stainless Steel – contact 1st Source Products Inc. for specifications and availability.

Also, available in Heat-Resistant version – contact 1st Source Products Inc. for specifications and availability.

PURCHASING DESCRIPTION:

General form: Bearing No./Style

Example: 55-LL Part No. 4-0192-003



2822 Sable Mill Rd., Jeffersonville, IN 47130
PH: 812-288-7466 FAX: 812-252-4728
<https://www.1stsourceproducts.com>
Email: sales@1stsourceproducts.com

#60 SERIES LOGAN BEARING DATA SHEET

Model #60-D Part Number 4-0193-002

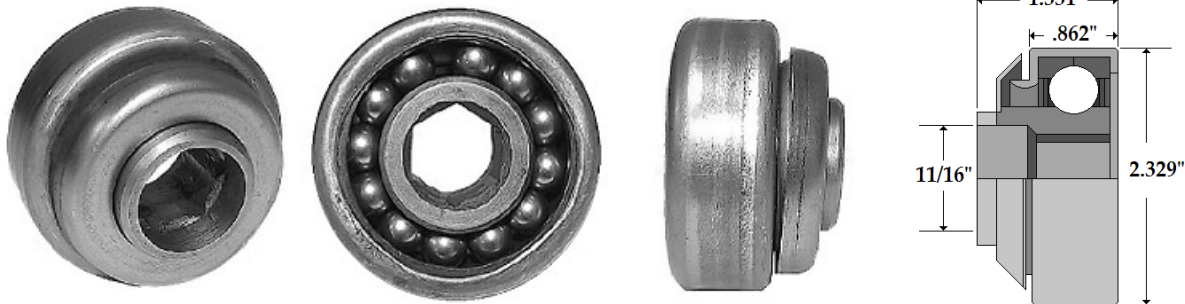

O.D. 2.329", HEX 11/16" 300 lb. Weight Capacity,
12 each 3/8" diameter carbon steel ball bearings, Shipping Weight: 13 OZ.

Model #60-LL Part Number 4-0193-003



O.D. 2.329", HEX 11/16" 300 lb. Weight Capacity,
12 each 3/8" diameter carbon steel ball bearings, Shipping Weight: 13 OZ.

*NOTE: These drawings indicate Basic Bearing Configurations. Contact 1st Source Products, Inc. for certified dimensions. Alternate Bearing Construction, such as: Lubrication, Grease Packed, Zinc Plated, Foundry, Heat Treated, Shot Shield Construction & Round Bore are available for Most bearing shown.



2822 Sable Mill Rd., Jeffersonville, IN 47130
PH: 812-288-7466 FAX: 812-252-4728
<https://www.1stsourceproducts.com>
Email: sales@1stsourceproducts.com

#60 SERIES LOGAN BEARING DATA SHEET

Model #60 Part Number 4-0193-001

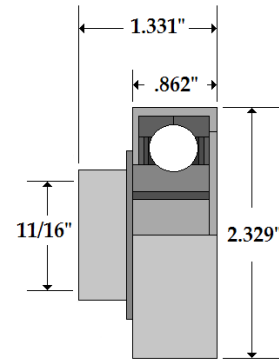

O.D. 2.329", HEX 11/16" 300 lb. Weight Capacity,
12 each 3/8" diameter carbon steel ball bearings, Shipping Weight: 13 OZ.

Model #60-RD Part Number 4-0193-005

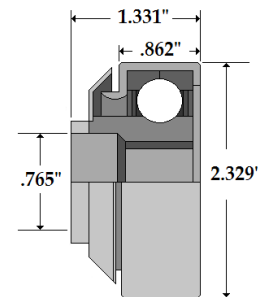

O.D. 2.329", Round Bore .765" I.D. 300 lb. Weight Capacity,
12 each 3/8" diameter carbon steel ball bearings, Shipping Weight: 13 OZ.

*NOTE: These drawings indicate Basic Bearing Configurations. Contact 1st Source Products, Inc. for certified dimensions. Alternate Bearing Construction, such as: Lubrication, Grease Packed, Zinc Plated, Foundry, Heat Treated, Shot Shield Construction & Round Bore are available for Most bearing shown.



2822 Sable Mill Rd., Jeffersonville, IN 47130

PH: 812-288-7466 FAX: 812-252-4728

<https://www.1stsourceproducts.com>

Email: sales@1stsourceproducts.com

#60 SERIES LOGAN BEARING DATA SHEET

The Dust-Protected Bearing (Style D) is provided with an outer shield which is fixed to the stationary inner race of the bearing, and does not touch any rotating part. In a reasonably dry-atmosphere, excellent results are obtained with no lubrication.

The Grease-Packed Bearing (Style GP) features the same construction as the Dust-Protected Bearing, but is pre-lubricated during assembly with a special long-life grease.

Lubricated-for-Life Bearings are constructed similar to the Dust-Protected type including the same labyrinth outer seal, but with an added built-in inner seal. Bearing is pre-lubricated during assembly with a special long-life grease.

The Lubricated-for-Life Bearing is recommended for Power Driven Rollers as used in Live Roller or Belt Conveyors. Also, suitable for Push Line Roller Conveyor, but NOT for Gravity Lines. DO NOT use this type in areas where there is dirt or grime, as this type has no provision for cleaning or re-greasing as with the Pressure-Lubricated Bearing.

Pressure-Lubricated Bearing construction is similar to the Dust-Protected, with the addition of a grease chamber behind the bearing plus a grease duct and pressure fitting in the shaft. The floating cup in the rear of chamber prevents entry of grease into interior of roll.

Alternate Bearing construction such as Lubricated-for-Life (Style LL), Pressure-Lubricated (Style L), Grease Packed (Style GP), Zinc Plated (Style ZP), and Round Bore (Style R) are available on most Bearings shown.

Note: These drawings indicate basic configurations. Do not use for design or construction. Contact 1st Source Products Inc. for certified dimensions.

Also, available in Stainless Steel – contact 1st Source Products Inc. for specifications and availability.

Also, available in Heat-Resistant version – contact 1st Source Products Inc. for specifications and availability.

PURCHASING DESCRIPTION:

General form: Bearing No./Style

Example: 60-LL Part No. 4-0193-003



2822 Sable Mill Rd., Jeffersonville, IN 47130
PH: 812-288-7466 FAX: 812-252-4728
<https://www.1stsourceproducts.com>
Email: sales@1stsourceproducts.com

#70 SERIES LOGAN BEARING DATA SHEET

Model #70-D Part Number 4-0194-001



O.D. 3.115", HEX 1" 1000 lb. Weight Capacity,
13 each 1/2" diameter carbon steel ball bearings, Shipping Weight: 23 OZ.

Model #70-LL Part Number 4-0194-002



O.D. 3.115", HEX 1" 1000 lb. Weight Capacity,
13 each 1/2" diameter carbon steel ball bearings, Shipping Weight: 23 OZ.

*NOTE: These drawings indicate Basic Bearing Configurations. Contact 1st Source Products, Inc. for certified dimensions. Alternate Bearing Construction, such as: Lubrication, Grease Packed, Zinc Plated, Foundry, Heat Treated, Shot Shield Construction & Round Bore are available for Most bearing shown.



2822 Sable Mill Rd., Jeffersonville, IN 47130

PH: 812-288-7466 FAX: 812-252-4728

<https://www.1stsourceproducts.com>

Email: sales@1stsourceproducts.com

#70 SERIES LOGAN BEARING DATA SHEET

Model #70-RD Part Number 4-0194-003

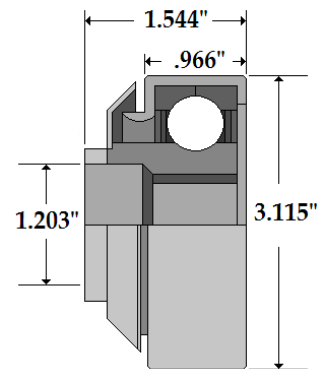

O.D. 3.115", Round Bore 1.203" I.D. 1000 lb. Weight Capacity,
13 each 1/2" diameter carbon steel ball bearings, Shipping Weight: 23 OZ.

*NOTE: These drawings indicate Basic Bearing Configurations. Contact 1st Source Products, Inc. for certified dimensions. Alternate Bearing Construction, such as: Lubrication, Grease Packed, Zinc Plated, Foundry, Heat Treated, Shot Shield Construction & Round Bore are available for Most bearing shown.



2822 Sable Mill Rd., Jeffersonville, IN 47130

PH: 812-288-7466 FAX: 812-252-4728

<https://www.1stsourceproducts.com>

Email: sales@1stsourceproducts.com

#70 SERIES LOGAN BEARING DATA SHEET

The Dust-Protected Bearing (Style D) is provided with an outer shield which is fixed to the stationary inner race of the bearing, and does not touch any rotating part. In a reasonably dry-atmosphere, excellent results are obtained with no lubrication.

The Grease-Packed Bearing (Style GP) features the same construction as the Dust-Protected Bearing, but is pre-lubricated during assembly with a special long-life grease.

Lubricated-for-Life Bearings are constructed similar to the Dust-Protected type including the same labyrinth outer seal, but with an added built-in inner seal. Bearing is pre-lubricated during assembly with a special long-life grease.

The Lubricated-for-Life Bearing is recommended for Power Driven Rollers as used in Live Roller or Belt Conveyors. Also, suitable for Push Line Roller Conveyor, but NOT for Gravity Lines. DO NOT use this type in areas where there is dirt or grime, as this type has no provision for cleaning or re-greasing as with the Pressure-Lubricated Bearing.

Pressure-Lubricated Bearing construction is similar to the Dust-Protected, with the addition of a grease chamber behind the bearing plus a grease duct and pressure fitting in the shaft. The floating cup in the rear of chamber prevents entry of grease into interior of roll.

Alternate Bearing construction such as Lubricated-for-Life (Style LL), Pressure-Lubricated (Style L), Grease Packed (Style GP), Zinc Plated (Style ZP), and Round Bore (Style R) are available on most Bearings shown.

Note: These drawings indicate basic configurations. Do not use for design or construction. Contact 1st Source Products Inc. for certified dimensions.

Also, available in Stainless Steel – contact 1st Source Products Inc. for specifications and availability.

Also, available in Heat-Resistant version – contact 1st Source Products Inc. for specifications and availability.

PURCHASING DESCRIPTION:

General form: Bearing No./Style

Example: 70-LL Part No. 4-0194-002



2822 Sable Mill Rd., Jeffersonville, IN 47130
PH: 812-288-7466 FAX: 812-252-4728
<https://www.1stsourceproducts.com>
Email: sales@1stsourceproducts.com

#75 SERIES LOGAN BEARING DATA SHEET

Model #75-D Part Number 4-0201-001

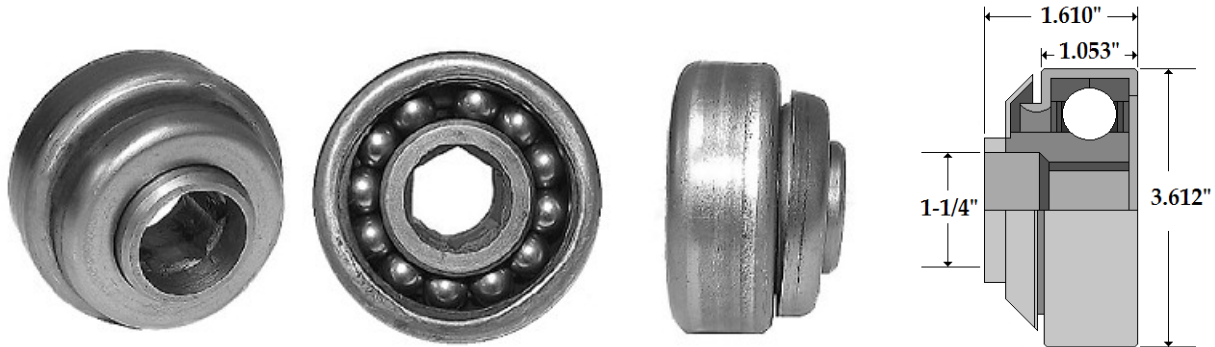

O.D. 3.612", HEX 1-1/4" 1,800 lb. Weight Capacity,
13 each 9/16" diameter carbon steel ball bearings, Shipping Weight: 33 OZ.

Model #75-LL Part Number 4-0201-002



O.D. 3.612", HEX 1-1/4" 1,800 lb. Weight Capacity,
13 each 9/16" diameter carbon steel ball bearings, Shipping Weight: 33 OZ.

*NOTE: These drawings indicate Basic Bearing Configurations. Contact 1st Source Products, Inc. for certified dimensions. Alternate Bearing Construction, such as: Lubrication, Grease Packed, Zinc Plated, Foundry, Heat Treated, Shot Shield Construction & Round Bore are available for Most bearing shown.



2822 Sable Mill Rd., Jeffersonville, IN 47130
PH: 812-288-7466 FAX: 812-252-4728
<https://www.1stsourceproducts.com>
Email: sales@1stsourceproducts.com

#75 SERIES LOGAN BEARING DATA SHEET

Model #75-RD Part Number 4-0201-003



O.D. 3.612", Round Bore 1.453" I.D. 1,800 lb. Weight Capacity,
13 each 9/16" diameter carbon steel ball bearings, Shipping Weight: 33 OZ.

*NOTE: These drawings indicate Basic Bearing Configurations. Contact 1st Source Products, Inc. for certified dimensions. Alternate Bearing Construction, such as: Lubrication, Grease Packed, Zinc Plated, Foundry, Heat Treated, Shot Shield Construction & Round Bore are available for Most bearing shown.



2822 Sable Mill Rd., Jeffersonville, IN 47130

PH: 812-288-7466 FAX: 812-252-4728

<https://www.1stsourceproducts.com>

Email: sales@1stsourceproducts.com

#75 SERIES LOGAN BEARING DATA SHEET

The Dust-Protected Bearing (Style D) is provided with an outer shield which is fixed to the stationary inner race of the bearing, and does not touch any rotating part. In a reasonably dry-atmosphere, excellent results are obtained with no lubrication.

The Grease-Packed Bearing (Style GP) features the same construction as the Dust-Protected Bearing, but is pre-lubricated during assembly with a special long-life grease.

Lubricated-for-Life Bearings are constructed similar to the Dust-Protected type including the same labyrinth outer seal, but with an added built-in inner seal. Bearing is pre-lubricated during assembly with a special long-life grease.

The Lubricated-for-Life Bearing is recommended for Power Driven Rollers as used in Live Roller or Belt Conveyors. Also, suitable for Push Line Roller Conveyor, but NOT for Gravity Lines. DO NOT use this type in areas where there is dirt or grime, as this type has no provision for cleaning or re-greasing as with the Pressure-Lubricated Bearing.

Pressure-Lubricated Bearing construction is similar to the Dust-Protected, with the addition of a grease chamber behind the bearing plus a grease duct and pressure fitting in the shaft. The floating cup in the rear of chamber prevents entry of grease into interior of roll.

Alternate Bearing construction such as Lubricated-for-Life (Style LL), Pressure-Lubricated (Style L), Grease Packed (Style GP), Zinc Plated (Style ZP), and Round Bore (Style R) are available on most Bearings shown.

Note: These drawings indicate basic configurations. Do not use for design or construction. Contact 1st Source Products Inc. for certified dimensions.

Also, available in Stainless Steel – contact 1st Source Products Inc. for specifications and availability.

Also, available in Heat-Resistant version – contact 1st Source Products Inc. for specifications and availability.

PURCHASING DESCRIPTION:

General form: Bearing No./Style

Example: 75-LL Part No. 4-0201-002



2822 Sable Mill Rd., Jeffersonville, IN 47130
PH: 812-288-7466 FAX: 812-252-4728
<https://www.1stsourceproducts.com>
Email: sales@1stsourceproducts.com

#85 SERIES LOGAN BEARING DATA SHEET

Model #85-D Part Number 4-0202-001



O.D. 4.031", HEX 1-1/2" 3,800 lb. Weight Capacity,
8 each 11/16" diameter carbon steel ball bearings, Shipping Weight: 45 OZ.

Model #85-RD Part Number 4-0202-002



O.D. 4.031", Round Bore 1.703" I.D. 3,800 lb. Weight Capacity,
8 each 11/16" diameter carbon steel ball bearings, Shipping Weight: 45 OZ.

*NOTE: These drawings indicate Basic Bearing Configurations. Contact 1st Source Products, Inc. for certified dimensions. Alternate Bearing Construction, such as: Lubrication, Grease Packed, Zinc Plated, Foundry, Heat Treated, Shot Shield Construction & Round Bore are available for Most bearing shown.



2822 Sable Mill Rd., Jeffersonville, IN 47130

PH: 812-288-7466 FAX: 812-252-4728

<https://www.1stsourceproducts.com>

Email: sales@1stsourceproducts.com

#85 SERIES LOGAN BEARING DATA SHEET

The Dust-Protected Bearing (Style D) is provided with an outer shield which is fixed to the stationary inner race of the bearing, and does not touch any rotating part. In a reasonably dry-atmosphere, excellent results are obtained with no lubrication.

The Grease-Packed Bearing (Style GP) features the same construction as the Dust-Protected Bearing, but is pre-lubricated during assembly with a special long-life grease.

Lubricated-for-Life Bearings are constructed similar to the Dust-Protected type including the same labyrinth outer seal, but with an added built-in inner seal. Bearing is pre-lubricated during assembly with a special long-life grease.

The Lubricated-for-Life Bearing is recommended for Power Driven Rollers as used in Live Roller or Belt Conveyors. Also, suitable for Push Line Roller Conveyor, but NOT for Gravity Lines. DO NOT use this type in areas where there is dirt or grime, as this type has no provision for cleaning or re-greasing as with the Pressure-Lubricated Bearing.

Pressure-Lubricated Bearing construction is similar to the Dust-Protected, with the addition of a grease chamber behind the bearing plus a grease duct and pressure fitting in the shaft. The floating cup in the rear of chamber prevents entry of grease into interior of roll.

Alternate Bearing construction such as Lubricated-for-Life (Style LL), Pressure-Lubricated (Style L), Grease Packed (Style GP), Zinc Plated (Style ZP), and Round Bore (Style R) are available on most Bearings shown.

Note: These drawings indicate basic configurations. Do not use for design or construction. Contact 1st Source Products Inc. for certified dimensions.

Also, available in Stainless Steel – contact 1st Source Products Inc. for specifications and availability.

Also, available in Heat-Resistant version – contact 1st Source Products Inc. for specifications and availability.

PURCHASING DESCRIPTION:

General form: Bearing No./Style

Example: #85-D Part No. 4-0202-001



2822 Sable Mill Rd., Jeffersonville, IN 47130

PH: 812-288-7466 FAX: 812-252-4728

<https://www.1stsourceproducts.com>

Email: sales@1stsourceproducts.com

#90 SERIES LOGAN BEARING DATA SHEET

Model #90-D Part Number 4-0204-001



O.D. 4.484", HEX 1-5/8" 4,000 lb. Weight Capacity,
8 each 3/4" diameter carbon steel ball bearings, Shipping Weight: 45 OZ.

Model #90-RD Part Number 4-0204-002



O.D. 4.484", Round Bore 1.953" I.D. 4,000 lb. Weight Capacity,
8 each 3/4" diameter carbon steel ball bearings, Shipping Weight: 45 OZ.

*NOTE: These drawings indicate Basic Bearing Configurations. Contact 1st Source Products, Inc. for certified dimensions. Alternate Bearing Construction, such as: Lubrication, Grease Packed, Zinc Plated, Foundry, Heat Treated, Shot Shield Construction & Round Bore are available for Most bearing shown.



2822 Sable Mill Rd., Jeffersonville, IN 47130

PH: 812-288-7466 FAX: 812-252-4728

<https://www.1stsourceproducts.com>

Email: sales@1stsourceproducts.com

#90 SERIES LOGAN BEARING DATA SHEET

The Dust-Protected Bearing (Style D) is provided with an outer shield which is fixed to the stationary inner race of the bearing, and does not touch any rotating part. In a reasonably dry-atmosphere, excellent results are obtained with no lubrication.

The Grease-Packed Bearing (Style GP) features the same construction as the Dust-Protected Bearing, but is pre-lubricated during assembly with a special long-life grease.

Lubricated-for-Life Bearings are constructed similar to the Dust-Protected type including the same labyrinth outer seal, but with an added built-in inner seal. Bearing is pre-lubricated during assembly with a special long-life grease.

The Lubricated-for-Life Bearing is recommended for Power Driven Rollers as used in Live Roller or Belt Conveyors. Also, suitable for Push Line Roller Conveyor, but NOT for Gravity Lines. DO NOT use this type in areas where there is dirt or grime, as this type has no provision for cleaning or re-greasing as with the Pressure-Lubricated Bearing.

Pressure-Lubricated Bearing construction is similar to the Dust-Protected, with the addition of a grease chamber behind the bearing plus a grease duct and pressure fitting in the shaft. The floating cup in the rear of chamber prevents entry of grease into interior of roll.

Alternate Bearing construction such as Lubricated-for-Life (Style LL), Pressure-Lubricated (Style L), Grease Packed (Style GP), Zinc Plated (Style ZP), and Round Bore (Style R) are available on most Bearings shown.

Note: These drawings indicate basic configurations. Do not use for design or construction. Contact 1st Source Products Inc. for certified dimensions.

Also, available in Stainless Steel – contact 1st Source Products Inc. for specifications and availability.

Also, available in Heat-Resistant version – contact 1st Source Products Inc. for specifications and availability.

PURCHASING DESCRIPTION:

General form: Bearing No./Style

Example: #90-D Part No. 4-0204-001

Other quality material handling products available from 1stSource Products, Inc. include:

E-Trac™ Enclosed Track Conveyor Equipment

- E-Trac-6 6" pitch enclosed track conveyor equipment
- E-Trac-8 8.125" pitch enclosed track conveyor equipment
- E-Trac Lite 6" pitch roundtube enclosed track conveyor equipment
- E-Trac-Q1 Side x side power & free equipment
- E-Trac-Q2 Over / under power & free equipment

X-Trac I-beam Monorail Equipment

- X-348 3" I-beam monorail equipment
- X-458 4" I-beam monorail equipment
- X-678 6" I-beam monorail equipment

Package Handling Equipment

- Ball transfer tables
- Belt conveyors
- Chain transfers
- Flexible / expandable conveyors
- Flow rails
- Roller conveyors (gravity and powered)
- Skatewheel conveyors
- Tire retread equipment www.1stsourceretread.com
- Turntables

Replacement Components

- Ball transfers www.1stsourceballtransfers.com
- Bearings www.1stsourcebearings.com
- Chain
- Casters
- Rollers
- Skatewheels
- Sprockets
- Trolleys

Other Product Lines

- Dura-Max Fence & Gate Hardware www.1stsourcefence.com
- 1stSource Industrial Hardware & Tools www.1stsourcecetoos.com
- 1stSource Industrial Hinges www.1stsourcehinges.com



1stSource Products, Inc. also has an OEM division specializing in prototyping and development of high quality subcomponents and complete assemblies for many different industries.